



**ATMO**  
sphere

# **Introduction of CO2 refrigeration systems to supermarkets and convenience stores**

**Sep 6, 2017**

**Hidekazu Tachibana  
External Relations Department  
Appliances Company  
Panasonic Corporation**

# AGENDA

1. Panasonic Cold Chain Business
2. Panasonic CO2 Refrigeration system
3. Field test & Installation experience in Asia & Europe

# AGENDA

1. Panasonic Cold Chain Business



**ATMO**  
sphere

# Panasonic 4 business domains

# #3

## Panasonic

### Appliances

HA • **Cold Chain** • HVAC • Devices



TV  
Home Appliances  
Air Conditioner  
Store Showcases

Panasonic Commercial  
Equipment Systems Co.,Ltd.

### Eco Solutions

Lighting • House Equipment  
• Environmental Engineering



Lighting Equipment  
Air Purifier & Ventilating  
Photovoltaic module  
Wiring device, etc.



### AVC Networks

AV • Network/Mobile communication



In-Flight Entertainment System  
PC/Tablet  
Security System, etc.

### Automotive & Industrial Systems

Automotive/Industrial devices • components



Manufacturing Machines  
Batteries  
Components  
Automotive devices, etc.







# ATMOsphere Panasonic Cold Chain Global Operation

# #4

Factory : Japan, China, Thailand, North & Central America

Sales Co.

PAPRSDL (Dalian, China)  
Semi-hermetic Compressor /  
Condensing Unit / Cold Storage / Engineering

PAPCDL (Dalian, China)  
Compressor for Air-conditioning  
/Refrigeration

PAPCCDL (Dalian, China)  
Showcase for supermarket /  
Beverage showcase / Cooling Unit  
Commercial Refrigerator

CCBD  
RADBD  
(Oizumi, Japan)

PCES(Tokyo, Japan)

Hussmann (Hussmann BD)  
Showcase / Condensing Unit /  
Engineering  
(ST. Louis, Monterey, Chino, Atlanta, etc)

PHK-CC (HK)

PCESTW (TW)

APIN-CC (IND)

PCESAP (SIN)

PAPCTH (Thailand)  
Beverage / Freezer /  
Showcase for supermarket

PAPRSMX (Tijuana, Mexico)  
Showcase for supermarket / Refrigerator /  
Bio apparatus

PAPRSA (San Diego, USA)  
Showcase for supermarket / Refrigerator /  
Bio apparatus



Showcase for Supermarket



CVS Showcase



Beverage Showcase



Commercial Refrigerator



Beverage Dispenser



Semi-hermetic Compressor



Rack Units



Screw Units

# AGENDA

## 2. Panasonic CO2 Refrigeration system



# ATMO CO2 refrigeration system sphere development

# #6

2005 Joined the project of Ministry of Economy,  
Trade and Industry (NEDO)

Component  
development

Japan  
1st\*

CO<sub>2</sub>(R744)自然冷媒採用  
ノンフロン冷凍機

※2010年5月25日現在



Period for baseline study

2009 Demonstration test started in supermarket

Field test



初代ノンフロン冷凍機

2010: CO<sub>2</sub> refrigeration system launched

2015: 2<sup>nd</sup> generation CO<sub>2</sub> refrigeration system  
【"Pressure adjust control" type】launched



Pressure adjust control type condensing unit

Point of "Pressure adjust control" type

- Regularized refrigerant pressure level
- Lighter & smaller body
- Improved workability and installation cost



## HFC/HCFC DX System

Large amount of refrigerant charge, remain as main stream in developing countries

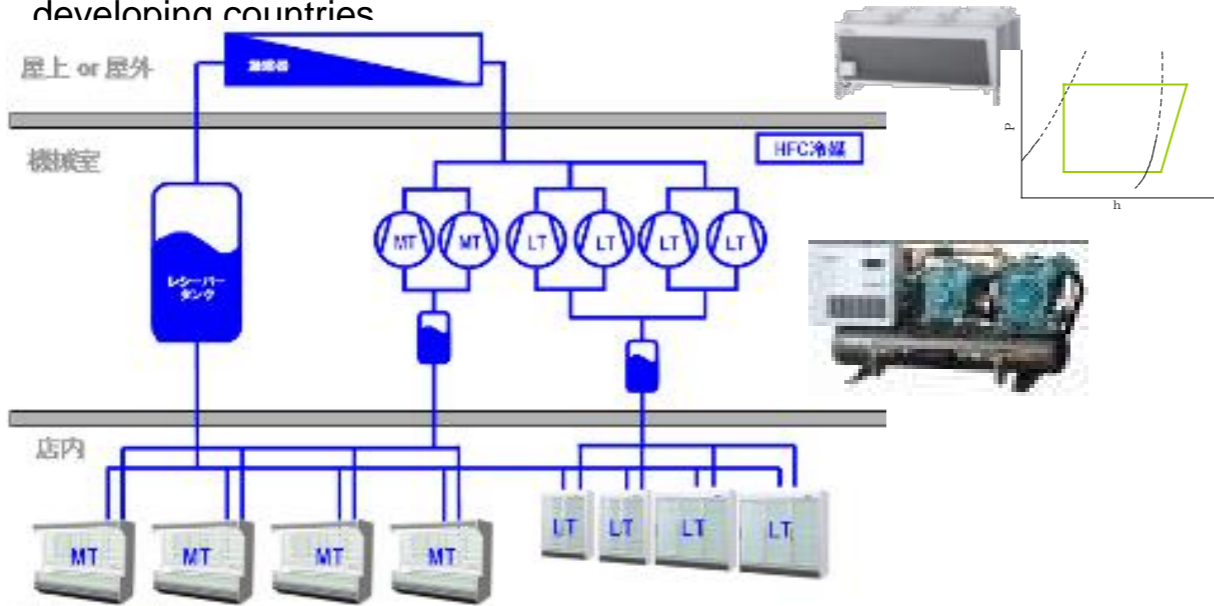

## CO<sub>2</sub> Booster System

Large amount of CO<sub>2</sub> charge, spreading in EU but efficiency drop in warmer area

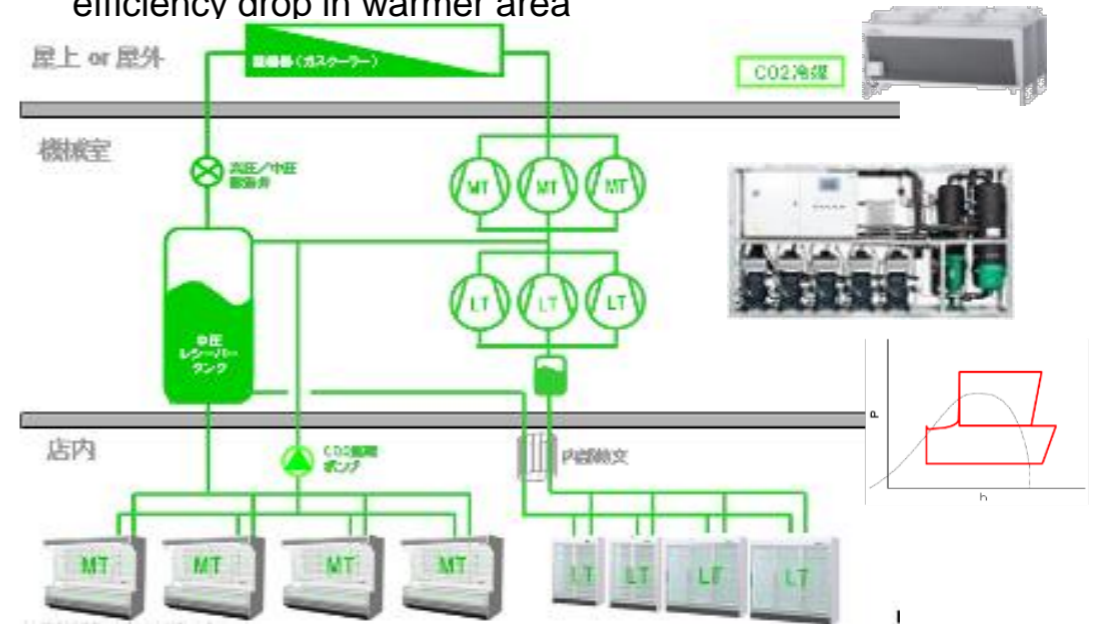

## HFC/CO<sub>2</sub> Cascade System

Less amount of HFC charge than HFC DX system, lower global warming impact from HFC leakage

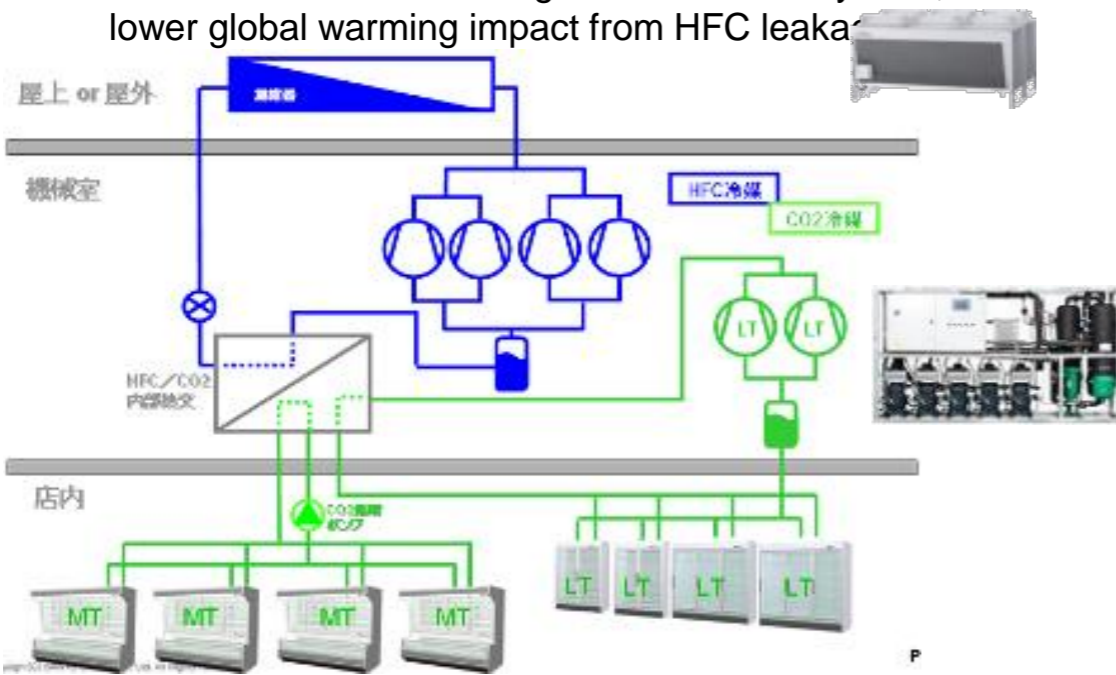

## CO<sub>2</sub> Split System

Decentralized condensing unit (Outdoor) Quick installation, less amount of CO<sub>2</sub> charge

High Pressure Piping

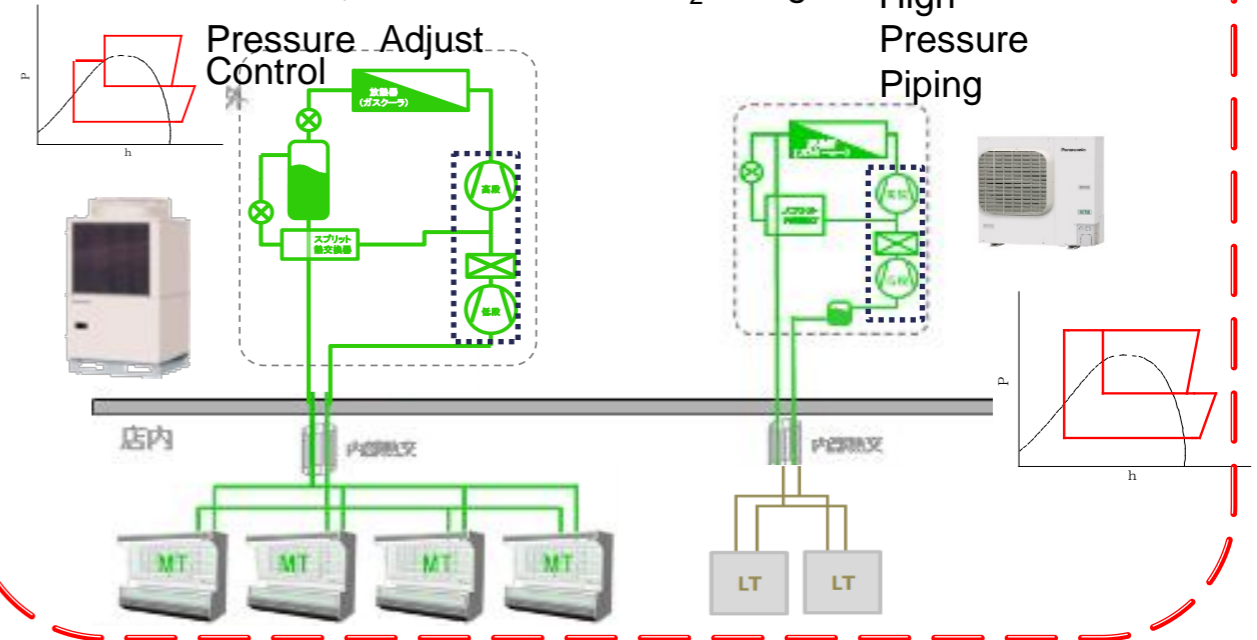





# ATMO Typical installation

# #8

CO<sub>2</sub> refrigeration system covers environmentally friendly small format stores.

## Convenience Store, Sales Floor Area: 150m<sup>2</sup>

Outdoor Unit	Showcase
10HP (Refrigerator)	Open Showcase (Total width 28 feet) Desert Showcase Walk-in Refrigerator (6 or 7 doors)
2HP (Freezer)	Reach-in Freezer (2 or 3 doors)

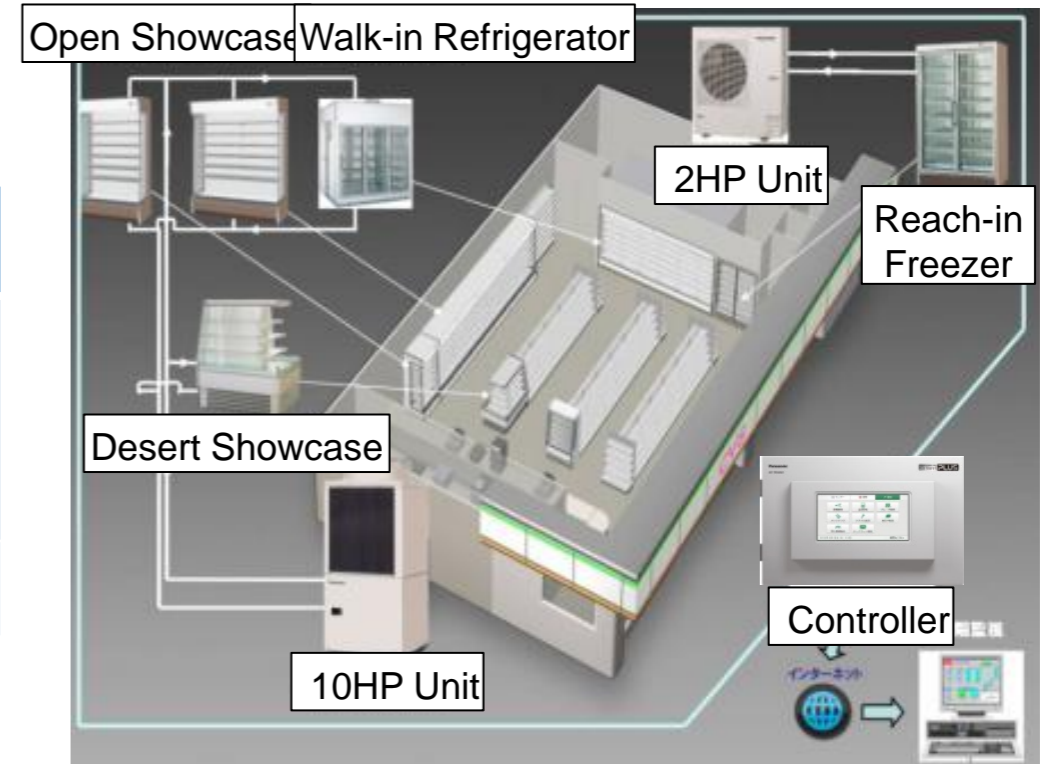

## Supermarket, Sales Floor Area: 1,000m<sup>2</sup>

Outdoor Unit	Showcase
20HP (Refrigerator) x7	Open Showcase (Total width 326 feet) Prefabricated Refrigerator x5
20HP (Freezer)	Prefabricated Freezer x3





# ATMOsphere Significant reduction of the annual CO<sub>2</sub> emissions

# #9

## Comparison of CO<sub>2</sub> emissions

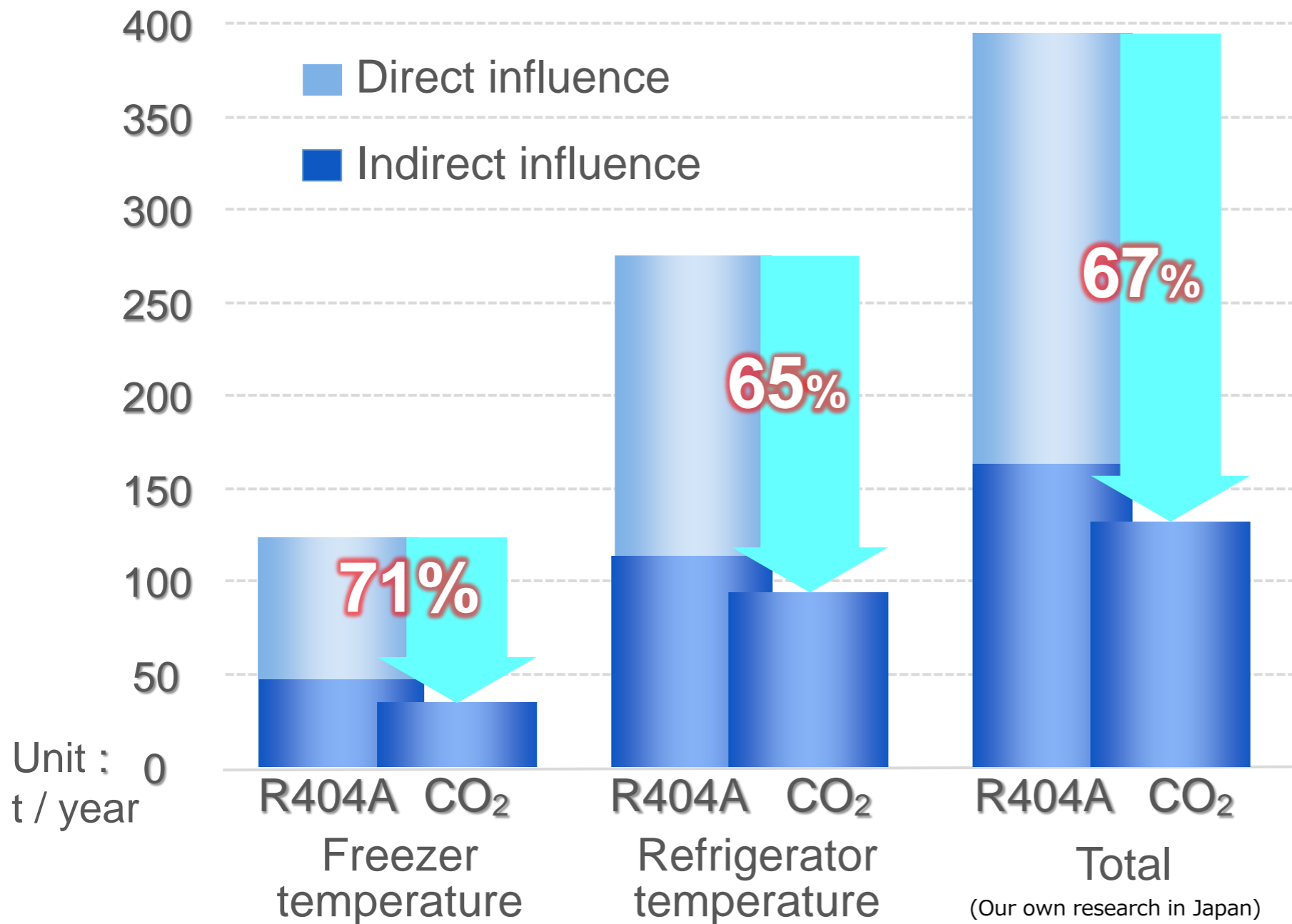

**Energy Saving**

**25.4%** (Freezer)  
**16.2%** (Refrigerator)

(Our own research on 6 stores in Japan)

**CO<sub>2</sub> emission**

**67% reduction**

※Comparing with 6 shop average of R404A inverter multi condensing unit  
 Electricity CO<sub>2</sub> conversion factor: 0.000579t-CO<sub>2</sub>/kWh  
 Refrigerant leakage rate: 16%

# AGENDA

## 3. Field test & Installation experience in Asia & Europe



# ATMOsphere CO2 system in Japan

# #11

Launched in 2010. Result until July 2017.

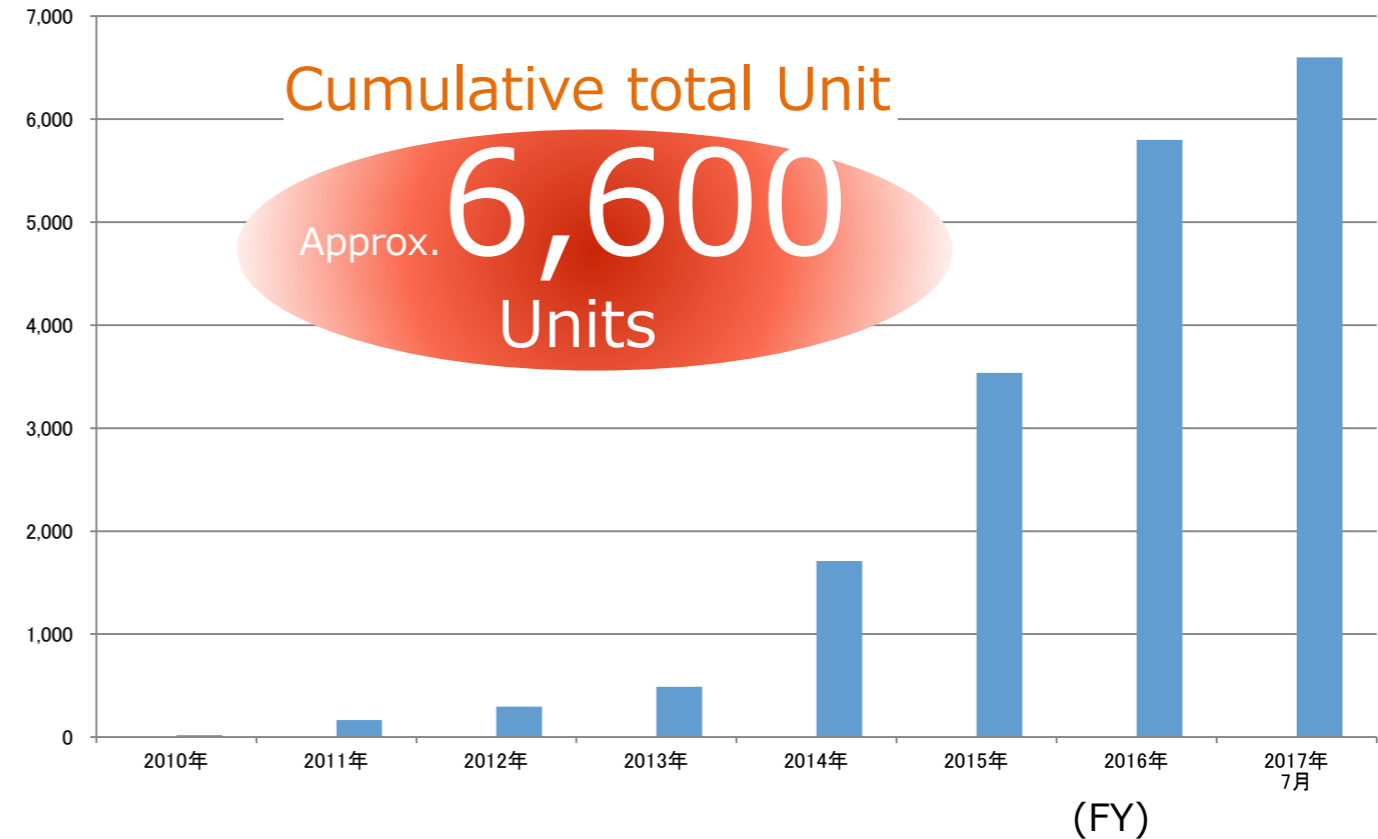
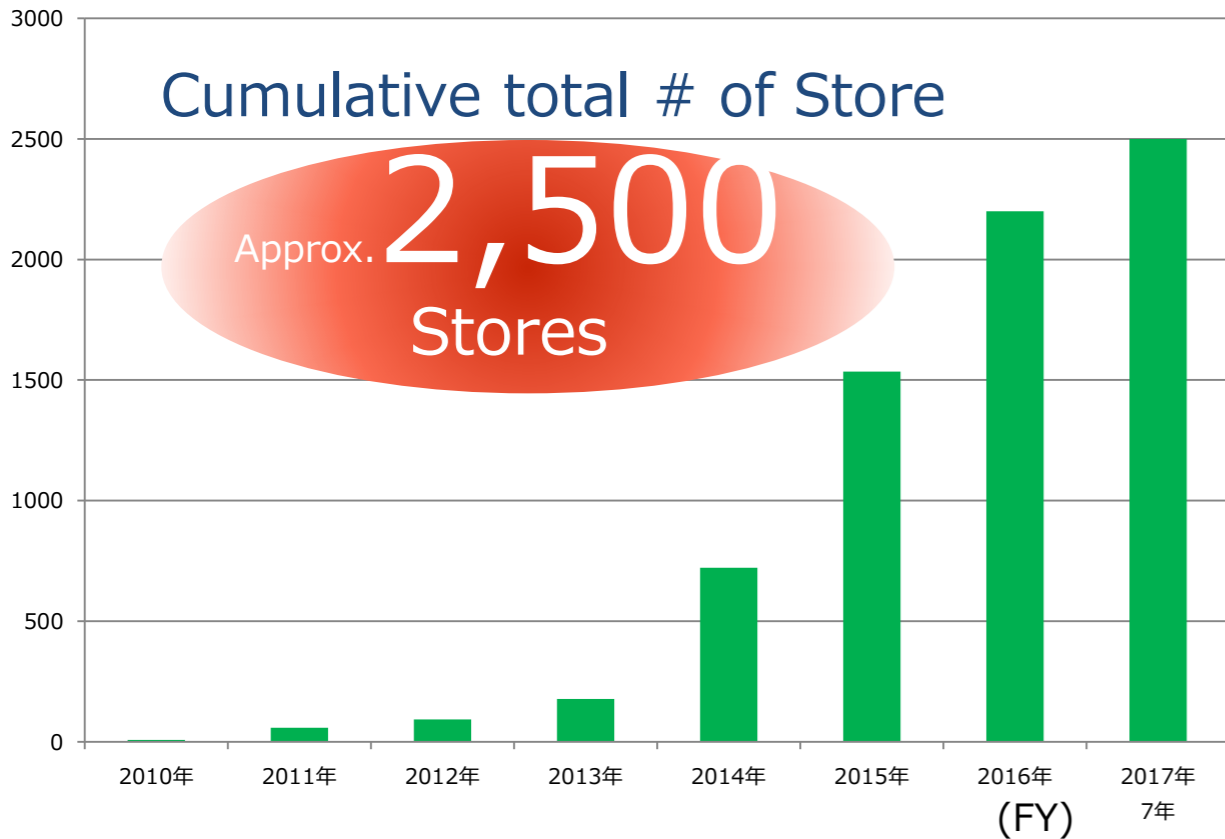





# ATMO CO2 System FT & installation sphere by region

# #12

## Panasonic CO2 system started global expansion

Area	Status	# of prospected installation
Europe	Jan 2016, 2HP CO <sub>2</sub> unit	200+



Area	Status	# of system installed
Japan	Launched in 2010	6,600+



Area	Status	# of system installed
Malaysia	May 2017 20HP CO <sub>2</sub> units	2

Area	Status	# of system installed
Taiwan	Dec 2015, 10HP CO <sub>2</sub> unit	2



Area	Status
Thailand	Under study

Area	Status	# of system installed
Indonesia	By government subsidy, 13 shops were introduced at the time of May 2015	26





**ATMO**  
sphere

**Thank you very much!**

